

Aladdin

WELDING PRODUCTS, INC.

Your White Metal Handbook





About Aladdin Welding Products, Inc.

Aladdin Welding Products, Inc. has grown from one man's dream in 1929 to a welding supply company with a worldwide customer base. What was once a company with one product, forged in the trunk of a car, is now a multi-product company with distributors servicing countries around the world.

We attribute our success to one thing: a commitment to being responsive to our customer. Our first product, the Aladdin 3-in-1 Rod—still a mainstay of the company, was created in response to industry need for a method to repair fractured castings. New products have been added through the years as a direct response to the needs of our customers.

Today, our list of quality products for low-temperature soldering, brazing, and welding includes: the Aladdin 3-in-1 rod, a Low Melt rod, a galvanizing bar, aluminum, silver, tin alloy solders, (spools, paste, and kits), several types of flux, wire and fiberglass brushes, soapstone pencils, and a miniature torch.



Contents:

Brazing Aluminum	4
Welding Zinc-Based Metals	6
Soldering Aluminum	8
Aluminum to Brass, Copper, & Stainless Steel	10
Silver Solder for Other Metals	12

How to use this booklet

The customer's satisfaction is one of Aladdin's greatest concerns. To best serve our customers is to give them complete and accurate information about our products and how to use them. This booklet is our answer to that need.



The procedures in this White Metal Handbook have been broken down into several basic steps, each clearly numbered.

Illustrations are given with each step to show clearly the techniques described in words below each picture.

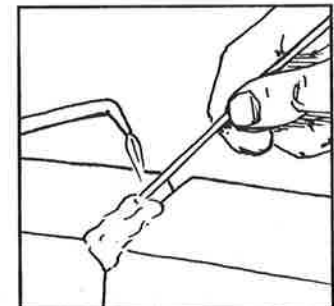

Specifications for each Aladdin product are given, so there will be no mystery as to their characteristics and appropriate application.

If any questions arise, please feel free to contact us:

Aladdin Welding Products, Inc.

1300 Burton St. SE
Grand Rapids, MI 49507

Phone: (616) 243-2531

FAX: (616) 243-9233

Brazing Aluminum with Aladdin #31 3-in-1 Rod*

About Aladdin 3-in-1 Rod, #31:

- Melting Point: 732° F
- Meets MIL-R-4208
- Available in 7 diameters from 1/32 to 1/4 inch, in 18 and 36 inch lengths
- **No flux required**

1

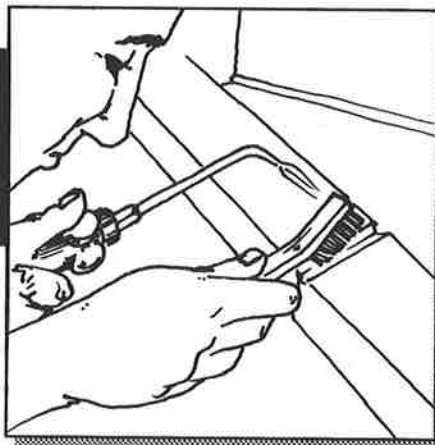

Brush surface to be repaired thoroughly under heat to break up surface oxide.

2

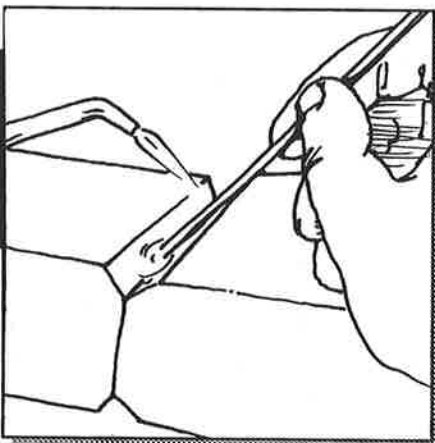

Heat the metal hot enough to flow the rod without the aid of the flame, thoroughly tinning the surface.

3

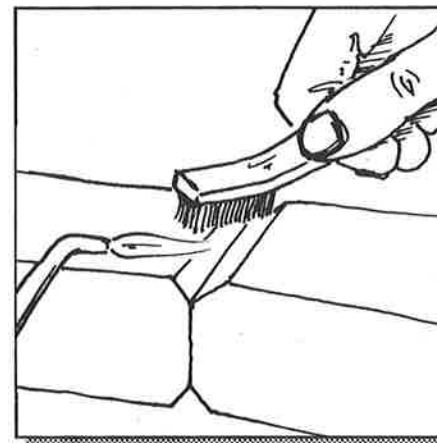

Brush tinned surface under heat, thoroughly filling open pores. This constitutes welding without fusion.

4

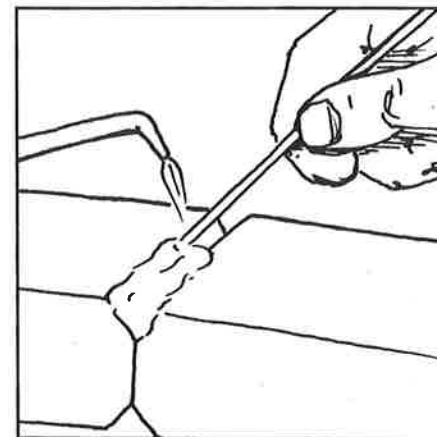

With sides thoroughly tinned, flow enough rod to fill the Vee. Be sure the filler metal fuses with the tinned surface without melting the base metal.

Welding Zinc-based Metals with Aladdin #31 3-in-1 Rod*

About Aladdin 3-in-1 Rod, #31:

- Melting Point: 732° F
- Meets MIL-R-4208
- Available in 7 diameters from 1/32 to 1/4 inch, and in 18 and 36 inch lengths
- No flux required

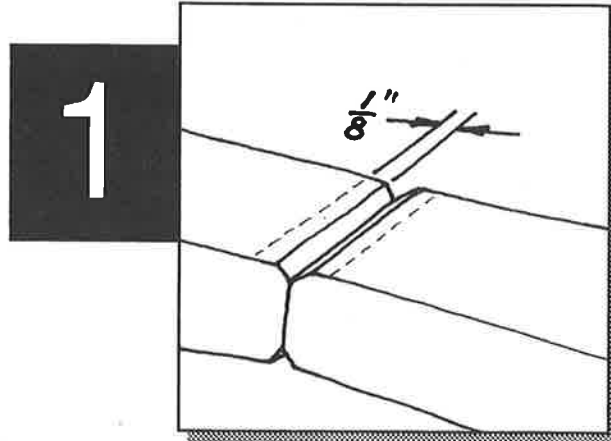

Vee the broken edges to about 45°. Clean the surface of any plating or scale back from the edges of the vee 1/8 inch.

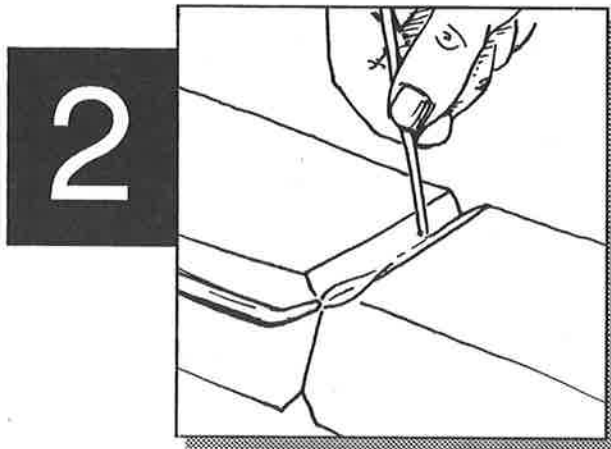

Heat the metal until it starts to flow. Turn the flame parallel to the surface. Hold the metal at this heat with the side of the flame. Heat the rod to the same temperature.

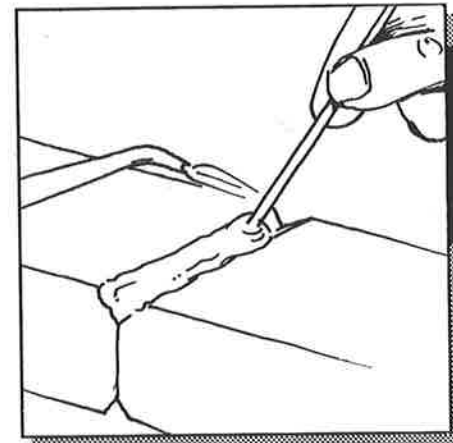

With both base metals and welding rod at the same temperature, touch the rod to the break. The rod will flow into the vee, thoroughly fusing. Repeat this procedure until the break is completely filled. Be sure to kick the rod into the weld to break down skin resistance as the filler rod will lay on the surface and will not fuse if only heat is applied.

Quik Tips ...

- When building up material, a dam of carbon or copper will keep the liquid metal in place.
- For protection from salt water on repaired surfaces, use Alodine 1201.
- Repaired surfaces will take paint or plating as well as the parent material

Soldering Aluminum with Aladdin #33 Low Melt Rod

About Aladdin #33 "Low Melt" Rod:

- Melting Point: 585° F
- Meets MIL-S-12204B, Type II Comp. B
- Available in rods 1/8 x 18", 1/4 x 14", and 3/64" wire.
- Use with Aladdin #585 flux

1

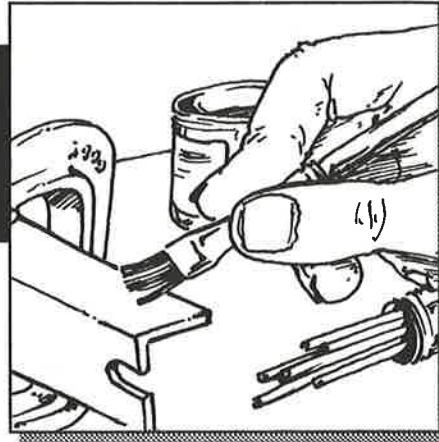

Clean the metal thoroughly. Stir flux well, then apply flux to both surfaces.

3

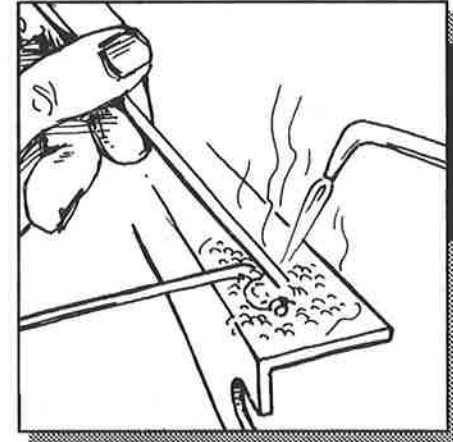

Immediately apply solder and melt quickly, putting the heat directly on the area to be soldered. Solder will creep into the joint.

2

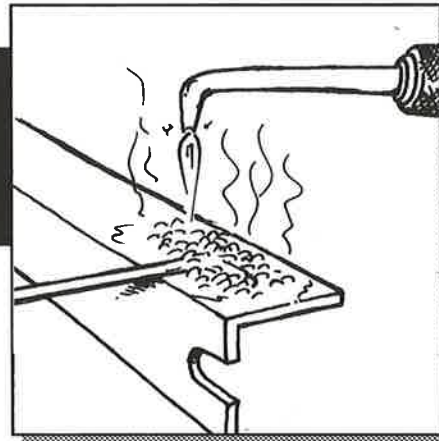

Position the parts and heat the metal indirectly until the flux boils and turns clear.

Quik Tips ...

- Solders Aluminum to Copper, Steel, Brass, Galvanized, Stainless Steel, and Monel Metal.
- Great for refrigeration work!
- Fills pin holes in Aluminum castings

Soldering Aluminum with Aladdin #604

About Aladdin #604 Solder:

- Melting Point: 400° F
- Meets Mil Spec QQ-S-571D
- Available in 1/16, 3/32, and 1/8 inch diameters on a 1 lb spool.
- Also available cored with Aladdin #1 flux (same sizes)

1

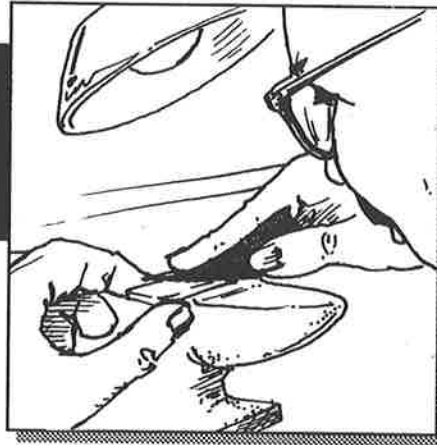

Thoroughly clean the surface to be soldered to remove surface oxide.

2

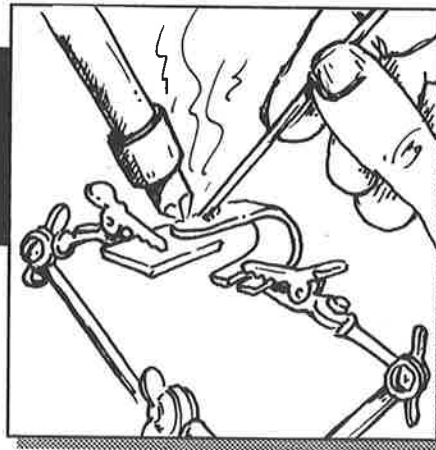

When using flux-cored solder, any common soldering technique can be used. Use low heat with torch or soldering iron.

3

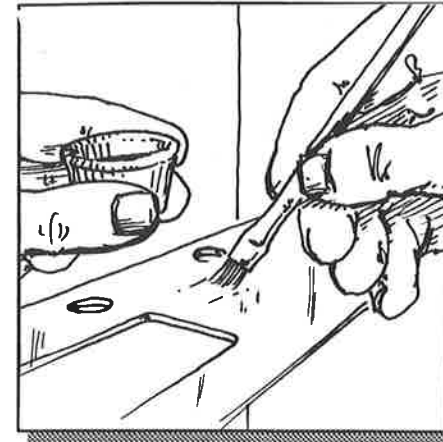

When using solder with #1 low temperature liquid soldering flux, apply flux to the cleaned area, heat, and apply solder. Use low heat with torch or soldering iron.

Quik Tips ...

- *Aladdin 604 will solder Aluminum to Copper, Brass, or Steel.*
- *NOTE: Aluminum will not change color when molten.*
- *Very good for fine work, as well as pressure-tight applications*
- *Excellent for soldering pewter; for an antique finish, brush with egg white.*

Soft Silver Soldering with Aladdin #450

1

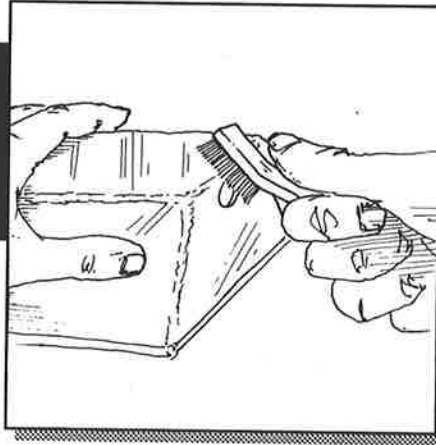

Thoroughly clean the metal surfaces.

2

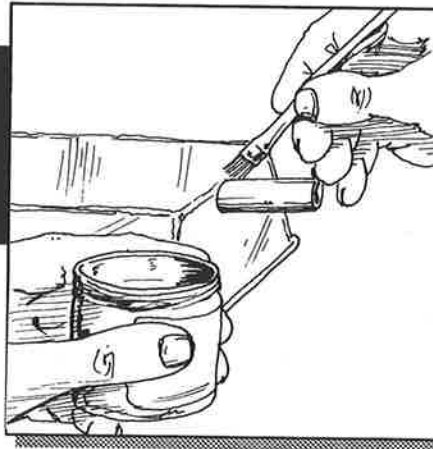

Apply the appropriate flux to the metal and heat.

About Aladdin #450 Soft Silver Solder:

- Melting Point: 430° F
- Meets Mil Spec QQ-S-5710
- Available in 3/64, 1/16, 3/32, and 1/8 inch diameters on a 1 lb spool
- FDA approved
- Use with Aladdin flux (See "Tips"!)

3

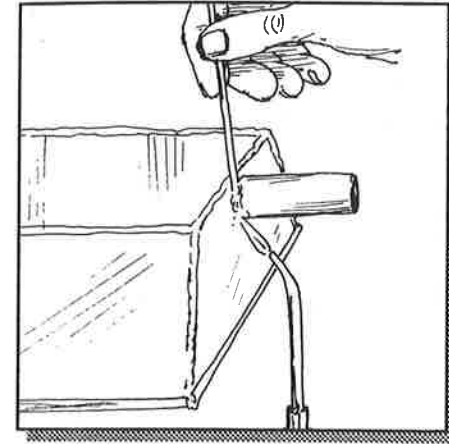

Any common soldering technique can be used.

Quik Tips ...

- Contains Silver — No lead, zinc, or cadmium
- Excellent for Stainless, Copper, Nickel Alloys, Monel, Brass, Bronze, and other non-ferrous alloys (but not Aluminum or Magnesium!)
- For Stainless Steel, use # 3 Soft Soldering flux; for all other common soldering, use # 2 Low-Acid all-purpose flux
- To neutralize # 2 and # 3 flux, use baking soda and water solution

Aladdin's Fiberglass and Stainless Steel Brushes

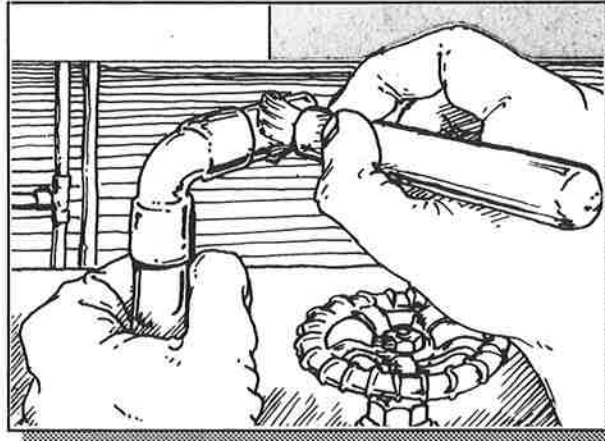

The plastic-coated fiberglass strands of the Aladdin #37 Fiberglass Brush are excellent for friction-tinning aluminum, and clean other metals readily. Makes an excellent flux brush, and in preparing metals for heliarc welding nonmetallic material.



Also available:

#48 "Mini" Stainless Steel
Tinning Brush

#49 "Mini" Stainless Steel

Aladdin's Fluxes



Aluminum Brazing Flux #71

The thorough cleansing action of #71 aluminum brazing flux ensures quick melting and easy spreading of the filler metal and prevents the formation of aluminum oxide on the base metal. This allows deep penetration of the rod metal and a strong, smooth joint. Recommended for use with #716 and #718 aluminum brazing rods.

- Melting Point:
approximately 950°F - 1075°F

Aladdin offers this flux in three standard sizes: 1/4 lb, 1/2 lb, and 1 lb jars.

Aluminum Welding Flux #73

#73 aluminum welding flux, for welding aluminum and its alloys, produces a strong, nonporous weld by keeping the base and rod metals free of oxides. When mixed with water, the flux forms a paste that is applied to the base and rod metals. Any residue is removed with warm water after welding.

Melting Point: 1100° F

Aladdin offers this flux in three standard sizes: 1/4 lb, 1/2 lb, and 1 lb jars.

Contact your local distributor.

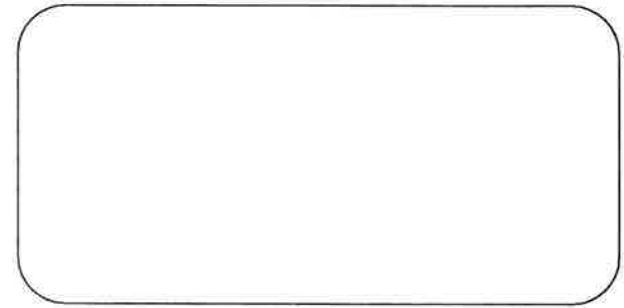

Aladdin Welding Products, Inc.
1300 Burton St., SE
Grand Rapids, MI 49507
FAX: (616) 243-9233
Phone: (616) 243-2531